

Evaluation of discharge coefficients of large openable windows using full-scale samples in wind tunnel tests

Evaluación de los coeficientes de descarga de grandes ventanas que se pueden abrir utilizando muestras a escala real en ensayos en túneles de viento

L. Fernandes ^{1*}, M. Friedrich **, D. Cóstola ***, E. Matsumoto ****, L. Labaki ****, F. Wellershoff **

* IMED – Passo Fundo, BRAZIL

** University Hamburg – Hamburg, GERMANY

*** University of Strathclyde – Scotland, UNITED KINGDOM

**** State University of Campinas, UNICAMP – Campinas, BRAZIL

Fecha de Recepción: 19/06/2019

Fecha de Aceptación: 25/11/2019

PAG 203-214

Abstract

Discharge coefficients (C_d) are key input data in the evaluation of energy performance of naturally ventilated buildings. Such buildings are characterized by large openings (windows, grills, vents) for which accurate experimental data are rarely available in the literature or from manufacturers. In order to contribute with an experimental method for assessment and with new C_d values from windows typically found in Brazil and Germany, this paper describes a set of experiments assessing the discharge coefficient of these windows for cross-ventilation. Experiments were carried out based on the standard BS EN 13141-1:2004 set-up in a wind-tunnel with full-scale models. The investigated sample also comprised windows whose C_d values were known for the validation of the method. Results for known windows are in line with previous work. Results of discharge coefficients for innovative windows (not yet available in the literature) were found. The work reduces assumptions in natural ventilation studies, contributing to the reliability of building performance assessment.

Keywords: Discharge coefficient; natural ventilation; wind-tunnel; energy performance; windows

Resumen

Los coeficientes de descarga (C_d) constituyen un dato de entrada clave para la evaluación del desempeño energético de edificios con ventilación natural. Estos edificios se caracterizan por grandes aberturas (ventanas, rejillas y respiraderos), donde los datos experimentales raramente están disponibles en la literatura o por parte de los fabricantes. Con el objetivo de contribuir con un método experimental para la evaluación y nuevos valores de C_d para ventanas de uso común en Brasil y Alemania, este artículo describe una serie de experimentos que evalúan el coeficiente de descarga de estas ventanas con ventilación cruzada. Se llevaron a cabo experimentos basados en la norma BS EN 13141-1:2004, configurando un túnel de viento con modelos a escala real. La muestra investigada presentó ventanas cuyos valores de C_d se conocieron mediante el método de validación. Los resultados para las ventanas conocidas concuerdan con trabajos previos. Se encontraron resultados de C_d para ventanas innovadoras (todavía no disponibles en la literatura). El trabajo reduce los supuestos planteados en estudios de ventilación natural, contribuyendo a la confiabilidad de las evaluaciones de desempeño de las edificaciones.

Palabras clave: Coeficiente de descarga; ventilación natural; túnel de viento; rendimiento energético; ventanas

1. Introduction

Recent efforts towards one of the sustainability goals in building design require estimating the behavior of building techniques, materials and components in search for better performance. It is necessary to understand, qualify and quantify the performance of those elements and strategies. Natural ventilation is a thermal energy-efficient alternative to achieve a comfortable and healthy environment. For that reason, it has been taken as criteria in worldwide known processes of certification and assessment of performance such as LEED and BREEAM.

The concern regarding the design of a natural ventilation system is part of the modern concept of intelligent buildings that adapt to the environment and to requirements of their occupants (Etheridge, 2015). The process of designing naturally ventilated buildings can be described in four stages: (i) assess technical feasibility of natural ventilation, (ii) choose of a ventilation strategy (e.g. single-sided or crossflow ventilation), (iii) technical design of the openings (such as size and position) and (iv) investigation on the performance of the system to comply with required internal air motion (Etheridge, 2016).

¹ Corresponding author:

IMED – Passo Fundo, BRAZIL

E-mail: luciana.fernandes@imed.edu.br



Therefore, the dimensioning of openings in buildings should be studied early in the design phase. The main parameter to be studied for a natural ventilation design is the rate of air exchange between the external and internal environment. Hence, it is necessary to know the effectiveness of an opening for ventilation. This property can be described by the discharge coefficient C_D which describes the ratio of: (a) the actual air flow and (b) the maximum air flow assuming there is no energy dissipation at the opening. The discharge coefficient is particular for each type of opening depending on factors related to the element itself (e.g. geometry) but also to external variables such as the angle of incidence of the wind on the facade. Due to the difficulty on estimating C_D values, they are not available from manufacturers.

Despite the aforementioned factors that influence C_D , typical values of C_D between 0.60 – 0.65 found in laboratory experiments for sharp-edged openings (ASHRAE, 2009); (AWBI, 2003); (Aynsley, 1999); (Linden, 1999) are largely adopted as a default in the current literature for different types of windows. As shown by (Heiselberg and Sandberg, 2006) this value does not apply for most of the windows used in real buildings and this simplification leads to overestimation of the air flow when used in building performance analysis.

In the last years, research on discharge coefficient values for openings has increased uncovering various techniques for its characterization. C_D values can be obtained by several means, such as small-scale experiments, full-scale experiments, numerical simulation among others and they will be discussed in the further sections.

To contribute with these studies on the energy performance of naturally-ventilated buildings this paper demonstrates the validation of a method to study real-sized openings in a wind-tunnel and also brings C_D values not found in the literature so far. The method is applied to different types of windows from Brazil and Germany and allows the study on the performance of large openings outside a wind-tunnel section. It is intended that the data obtained with this method can be used in building energy performance simulations.

This project was developed through the partnership between the State University of Campinas (Unicamp - Campinas, Brazil) and HafenCity University Hamburg (HCU - Hamburg, Germany) and windows manufacturers: Lenderoth (Germany) and MGM (Brazil). The companies provided samples of windows and the wind-tunnel experiments were conducted at Unicamp. It is worth noting that the aim of the research is not providing technical assistance to the companies, but to validate the assessment method by testing the windows whose C_D is known and to unveil data not yet found in the literature. This data is essential to support the reliable adoption of innovative windows in naturally ventilated building.

2. Review on discharge coefficients

Discharge coefficients are key input data in the evaluation of energy performance and indoor air quality of naturally ventilated buildings (Karava et al., 2004). Such buildings are characterized by large openings (windows, grills, vents) in contrast with sealed buildings where air exchange with the outdoor environment takes place through cracks and via a dedicated mechanical ventilation system. The characterization of such large openings by their discharge coefficients is a complex task. The discharge coefficient is not a constant value (Heiselberg and Sandberg, 2006); (Wang et al., 2017) depending on the opening properties such as type, geometry, area (Yi et al., 2018) and presence of insect screens (Chu et al., 2017). It is also dependent of external factors as the pressure difference induced by wind and temperature gradients, as well as of flow direction (inward/outward), angle of incidence of the wind, presence of turbulence and on the Reynolds Number (Aynsley, 1999); (Cruz and Viegas, 2016); (Flourentzou et al., 1998); (Scarpa et al., 2014); (Yi; Li et al., 2019); (Yi et al., 2019). This combination of factors hinders the proper evaluation of discharge coefficients for large openings. The discharge coefficient can be described by the orifice equation defined in (Equation 1):

$$C_D = \frac{Q}{A} \sqrt{\frac{\rho}{2\Delta P}} \quad (1)$$



Where:

C_D is the discharge coefficient (-),

Q is the air flow (m^3/s),

A is the area of the opening (m^2),

ρ is the air density (kg/m^3),

ΔP is the difference of static pressure (Pa).

Methods to evaluate the discharge coefficient of openings for wind-driven cross-ventilation have been developed based on empirical methods, wind-tunnel test, measurements in real buildings, laboratory tests and numerical simulations using Computational Fluid Dynamics (CFD) (Karava et al., 2004). The databases generated by these methods for commonly used opening geometries facilitate the adoption of values of discharge coefficient by practitioners. Such data can be found in building performance simulation manuals and codes, ventilation textbooks (Allard and Santamouris, 1998); (Etheridge, 2012); (Tamura and Yoshie, 2016) and scientific articles (Aynsley, 1999); (Belleri et al., 2014); (Chiu and Etheridge, 2007); (Chu et al., 2009); (Iqbal et al., 2015).

One of the major databases of C_D was developed by an extensive set of experiments by (Idel'chik, 1966). This database comprises data on coefficients of flow resistance (ζ) of elements of hydraulic (pipes and conduits), devices for heat exchange, ventilation (a variety of windows configuration), among others for calculation of hydraulic lines. An increasing flow resistance leads to a decreasing flow and consequently the discharge coefficient decreases as well. Thus, C_D can be calculated from ζ through (Equation 2). Data for resistance coefficients of stream passage through orifices are obtained from calculation formulas, experimental data and theoretical formulas. However, while the discharge coefficient of orifices depends on velocity distribution and the Reynolds number, for window openings it depends on geometrical parameters and on the airflow through them (Heiselberg and Sandberg, 2006).

$$C_D = \sqrt{\frac{1}{\zeta}} \quad (2)$$

Despite the variety of data regarding the characterization of openings and windows configurations, there are many other window types used nowadays to be investigated. According to a review done by (Chen, 2009), full- and small-scale models have been used to validate analytical, empirical or numerical models for studying ventilation performance in buildings and both are subject to approximations of boundary conditions and flow geometry. The most popular numerical models are CFD, but there is still work to be done in order to provide reliable results to this method (Chen, 2009); (Karava et al., 2004).

The geometry and details of actual windows found in buildings influence their performance for ventilation, therefore, the evaluation of full-sized windows in laboratory is a more suitable method (Ohba et al., 2004). Many window types currently used in buildings are not characterized regarding their C_D . This fact forces practitioners of building performance simulation to use generic values found in databases in the literature. The use of these generic values increases the uncertainty in simulation results (Chiu and Etheridge, 2007), potentially compromising the adoption of natural ventilation solutions in building design. Therefore, there has been recent efforts to reduce the uncertainties for predicting natural ventilation in buildings (Lamberti and Gorlé, 2018), (Shirzadi et al., 2018). Given the popularity of CFD models for building performance simulation and that there is a clear need for empirical data on C_D to feed databases, the present article contributes to a data base on C_D values and a method for this characterization.

3. Materials and method

This section starts with a technical description of the wind-tunnel used for the measurements, followed by details of the window samples from Brazil and Germany. The set-up of the experiment for the measurements of pressure difference and air velocity is detailed in the third section.



3.1 Wind-tunnel

For avoiding scaling errors due to complex geometry of the windows, the measurements are done directly with real windows installed on the inlet of a wind-tunnel. The set-up is based on the standard BS EN 13141-1:2004 (BSI, 2004) that gives recommendations on measuring volume flow rate through openings. The wind tunnel used is a linear open-circuit wind-tunnel of 9.03 m length with a test section of 4.80 m length (within the minimum distance between inlet and outlet of 0,5 m required by the standard). The cross section is reduced about six times from the inlet (4.20 m^2) for reducing the turbulence and the flow to become laminar, resulting in a transversal area of 0.72 m^2 . The upper part of the test section is adjustable to equalize the static pressure along it. Finally, the air passes through a diffuser of 1.25 m diameter (Figure 1) and (Figure 2).



Figure 1. View of the wind-tunnel. On the left, the cone where the air comes in suctioned by the fan on the right.

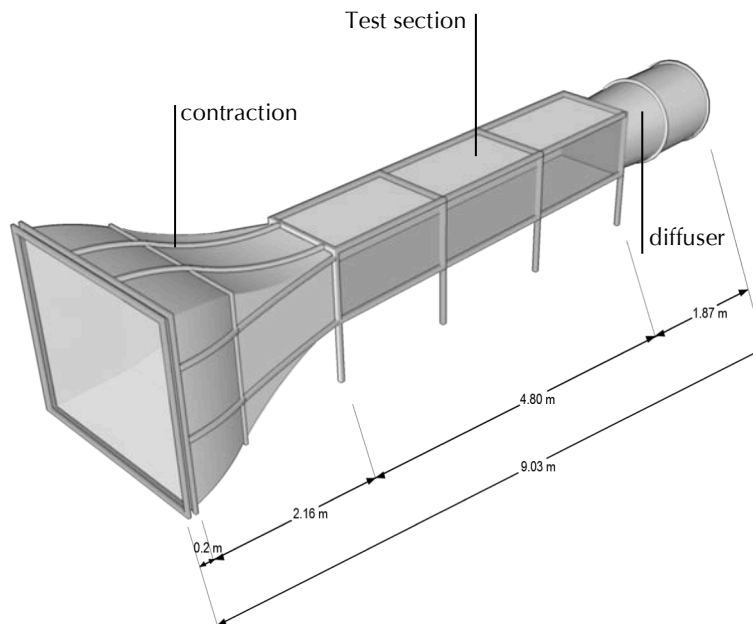

Figure 2. Components of the wind-tunnel and dimensions.



The windows are mounted in the inlet section of the wind tunnel (Figure 3). They are attached on a MDF board fitted in the inlet section. The board of 15 mm thickness is rigid enough to avoid pulsing airflow but not as thick as a wall to interfere on the measurements.



Figure 3. Board fixed at the inlet of the wind-tunnel with an orifice of 40 x 40 cm.

3.2 Window samples

The first step of the experiment is to validate the method using as a reference the aforementioned work of (Idel'chik, 1966). For this purpose, some openings whose C_D are known are tested: an orifice of 40 x 40 cm (Figure 3) and five additional windows. In total, seven windows are tested for this research. Their pictures are shown in (Table 1) and (Table 2) followed by: type (commercial name or opening mechanism), denomination (how they are referred to in this article), nominal area and brief description on operation.



The tilted window (A) allows the control of airflow and is largely used in Brazil for ventilation of bathrooms. The "boca de lobo" type (B) provides permanent ventilation and cannot be adjusted. The "veneziana" types (C and D) are largely used for lighting and ventilation in bedrooms and also living rooms in Brazil. Both types of "veneziana" investigated are made of six panes: two fixed panes with no gaps for incoming air, two sliding panes with glass and two sliding panes with gaps for ventilation that differ the two types of "veneziana". The "flaps" type (C) has adjustable devices for air inlet, while the "holes" type has small holes that allow permanent ventilation and it is not adjustable.

Table 1. Description of Brazilian windows tested in the wind-tunnel.

| | Picture | Details |
|---|---|---|
| A |  <p style="text-align: center;">(a) (b)</p> | <p>Type Máximo ar</p> <p>Denomination (a) Tilted 45°; (b) Tilted 90°</p> <p>Nominal area 0.16 m²</p> <p>Description awning window, tilted outside</p> |
| B |  | <p>Type Boca de Lobo Fixo</p> <p>Denomination Boca</p> <p>Nominal area 0.16 m²</p> <p>Description two parallel panes, permanent open, gap in between</p> |
| C |  | <p>Type Veneziana Eco Flex</p> <p>Denomination Flaps</p> <p>Nominal area 1.20 m²</p> <p>Description sliding panels with adjustable flaps</p> |
| D |  | <p>Type Veneziana</p> <p>Denomination Holes</p> <p>Nominal area 1.20 m²</p> <p>Description sliding panels with holes</p> |



Table 2. Description of German windows tested in the wind-tunnel.

| Picture | | Details |
|----------------|---|--|
| <i>E</i> |  | Type <i>Parallelausstellfenster</i> |
| | | Denomination <i>PAF</i> |
| | | Nominal area <i>1.00 m²</i> |
| | | Description <i>adjustable parallel opening</i> |
| <i>F</i> |  | Type <i>Dreh-Kipp-Fenster</i> |
| | | Denomination <i>DKF</i> |
| | | Nominal area <i>1.00 m²</i> |
| | | Description <i>base-hinged, tilted inside</i> |
| <i>G</i> |  | Type <i>Dachfenster</i> |
| | | Denomination <i>Roof</i> |
| | | Nominal area <i>1.00 m²</i> |
| | | Description <i>Top-hinged, tilted outside</i> |



The parallel opening (E) can be adjusted to control the airflow through it. The DKF window opening mechanism allows its glass pane to be bottom- or side-hung. For this experiment, the base-hinged position was investigated. The roof window (G) is also mainly used in residential buildings for lighting and natural ventilation of the attic. It is usually installed in tilted roofs of residential buildings. In these experiments, it is vertically installed and considered in the analysis as a top-hung window. All German windows presented in this study are triple-glazed resulting in a complex and strong frame construction.

3.3 Measurements of pressure difference and air velocity

The pressure difference is measured by taps around the window flush to the outside face of the board (Figure 4) and (Figure 5) and at the inside surface of the wind tunnel walls (Figure 6). Similar setup is described in the work of (Chu et al., 2009). (Chiu and Etheridge, 2007) suggest that the pressure taps should be placed far enough from the opening so that the flow through the opening does not influence the pressure, but close enough to minimize the effect of non-uniformity in the pressure field. Therefore, the external pressure taps are uniformly distributed following the same pattern in all measurements: 10 cm away from the edges of the windows and between each other. The distances between the edges of the board and the edges of the openings are larger than 0.3 m.

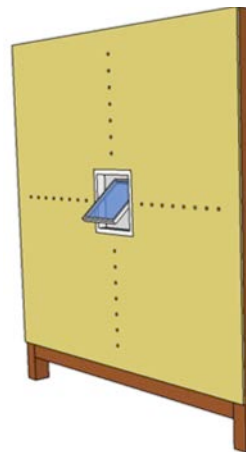

Figure 4. Schematics of the pressure taps distribution around the opening.



Figure 5. Board with a window sample and pressure taps on the left.



The internal pressure taps are installed on the surfaces of the contraction area of the wind tunnel (Figure 6). They are located behind the board in the mid-height of the vertical surfaces and in the mid-width of the horizontal surface. All taps are connected to a scanner pressure from Pressure Systems model 16TC/DTC with 64 channels and the data acquisition module DTC Initium.

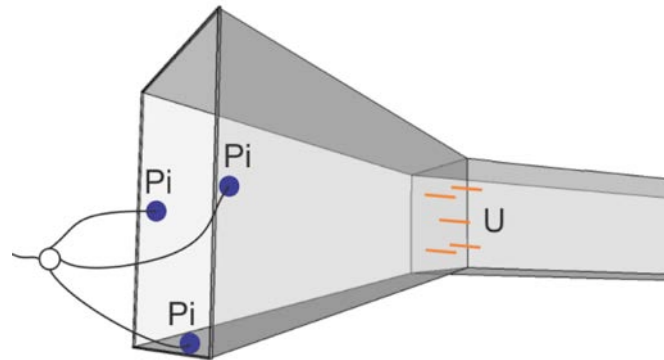

Figure 6. Schematics of the pressure taps and velocity sensors inside the wind-tunnel.

Hot-wire anemometers are uniformly distributed across the test section to measure the mean air velocity. The set comprises the Multi-Channel CTA System from Dantec Dynamics and a module for data acquisition from National Instruments model BNC-2110.

The tests were carried out using various fan speeds, and in all cases a fully developed turbulent flow was obtained. As the results obtained were Reynolds independent, this paper only reports values obtained at maximum speed. Data are recorded with a frequency of 330 Hz. To avoid errors resulting from fluctuations, the mean data for each fan speed are used.

4. Results and discussion

The discharge coefficients are calculated using the orifice equation from measured values of pressure differences and calculated airflow. Estimating air flow through complicated geometries of windows is difficult and leads to high uncertainties (Heiselberg et al., 2001). Therefore, the nominal area of the windows is used to calculate the discharge coefficient instead of the geometrical opening area. This simplification also makes data input easier for computer simulation, and the calculated C_D already takes into account the peculiarity of the geometry. The results are classified in two groups: the first represents the validation of the method and values are compared with data from (Idel'chik, 1966). The second group presents discharge coefficient values of windows not found in literature.

For the first group (Figure 7), most of the values are slightly above the values given in the literature. The openings named "Holes (open)", "Orifice" and "Flaps (open)" are compared to sharp-edged orifices. However, it should be clarified that the here tested openings did not have sharp edges which is a certain difference to the sharp-edged orifices from the literature. The C_D of the here tested openings is between 5% and 12% higher than the literature.

The "DKF" and "Roof" windows are both compared to single top-hinged flaps. The C_D of these windows are, respectively, 9% and 39% higher than the literature. Here, it is also expected that they present different values compared to those from the referred literature. The "DKF" is an intake bottom-hinged window and the geometric comparable opening found in (Idel'chik, 1966) is an exhaust, single top-hinged flap. Therefore, some differences between our results and results from literature are expected.

The C_D values for the tilted windows (45° and 90°) are underestimated. Both have single-glazed panes, but their geometry is complex as it has lateral hinges, which interfere on the incoming airflow. Besides, they open in a slightly different manner from the examples taken from Idel'chik. The pane is not exactly center-hinged, it slides from the upper part of the casement held by the hinges (Table 1), figures (a) and (b)). It means that its position in the casement is different from the one presented by Idel'chik. Considering that the pane obstructs the incoming flow (Hult et al., 2012), it is also expected to obtain different results from the literature.

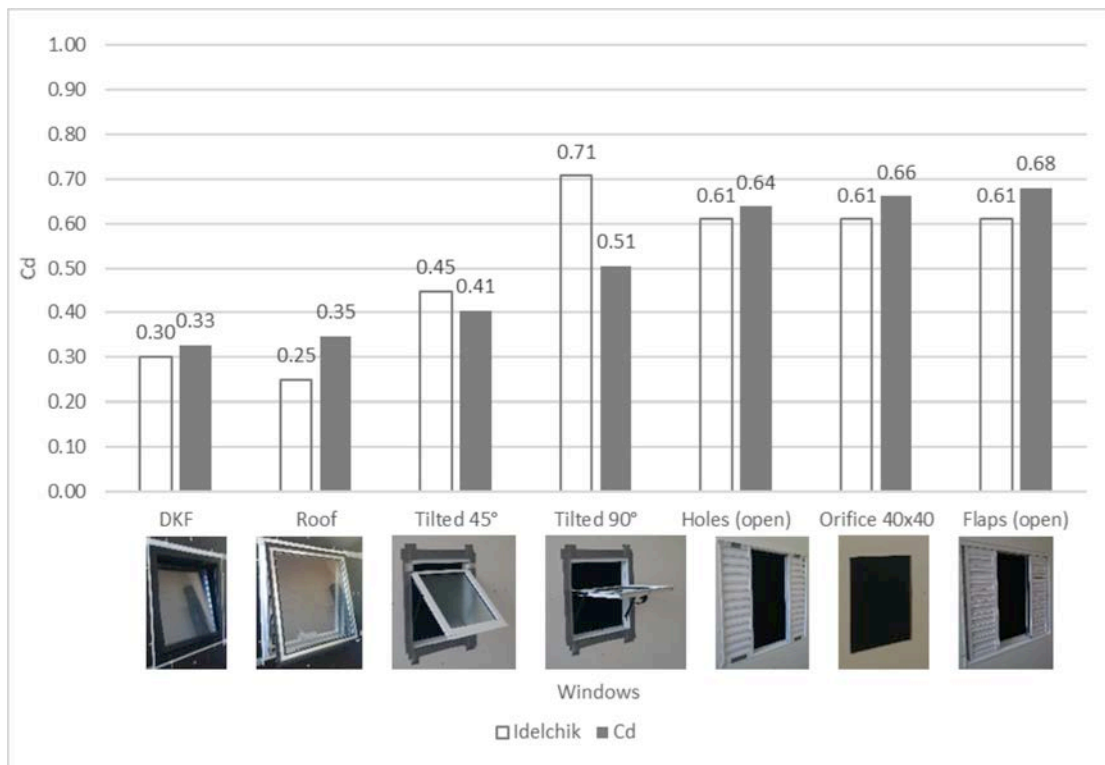

Figure 7. Comparison of discharge coefficient values calculated and from the literature.

The results of the second group, whose C_D values are not found in literature, are presented in (Figure 8). The “Holes (closed)” looks like a perforated plate in a corrugated surface, but its holes are facing down, conforming an obstacle for the incoming airflow. Therefore, it presented the lowest C_D value (0.06). The “Flaps” window also has a corrugated surface but bigger gaps than the window “Holes”. As expected, it obtains a higher C_D value (0.24). The passage for the airflow in the “Boca” window is similar to a rectangular opening. However, its parallel fixed panes cause an obstruction to the airflow, leading to a low C_D value of 0.13. In short, the results for these three openings are expected to be lower than the first group, regarding their geometry and effective area for ventilation. Considering that the C_D value for a sharp-edged orifice lies around 0.61, it is interesting to notice that the parallel opening “PAF” presents $C_D=0.55$, a high value which indicates low levels of energy dissipation in this type of opening geometry.



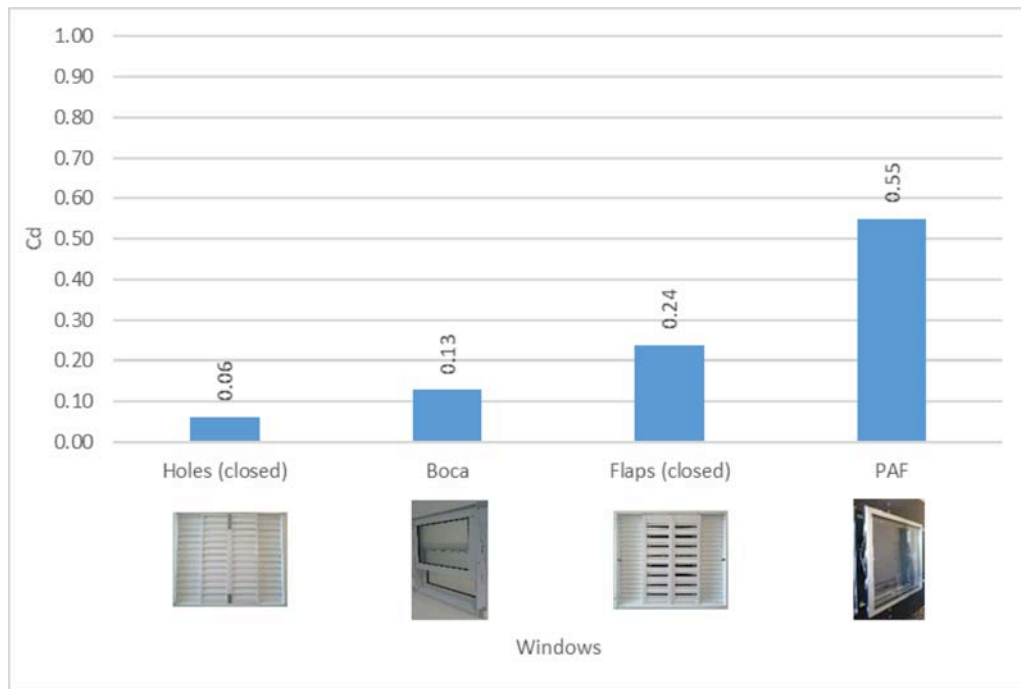

Figure 8. Calculated discharge coefficients for windows not found in the literature.

5. Conclusions

This paper describes a method to assess the discharge coefficients in full-scale windows and present values previously unknown for different types of windows commonly used in Brazil and Germany. The discharge coefficient is a key input for building simulations to evaluate the performance of naturally ventilated buildings. Whenever the discharge coefficient for a specific window type is unknown the user of computer simulation software has to assume this important input data. Obviously, this method undermines the reliability of the analysis. This paper aims to help practitioners of building energy simulation to achieve more accurate results when analysing the ventilation performance in buildings.

Considering the assumptions adopted in this work, the method described was validated by comparing the results of the experiments with data from the literature. The limitations and main conclusions of this paper are:

- The experiment is limited to study the C_D values of windows regarding cross-ventilation condition. It is known from previous work that single-sided ventilation would unveil different values;
- For some of the windows tested, no comparable types of windows are found in the literature. However, similar constructions are found to gather an idea about the magnitude of C_D . Despite the differences found between the results and the reference values, those are in line with the literature, considering what is known about the physical phenomena of fluid mechanics through openings;
- Laboratory experiments are expensive but they provide accurate results. Given the popularity of mathematical models for simulation of fluids, it is required to verify these models with reliable data from experiments;
- Further studies on performance of openings should be done considering the windows for single-sided ventilation and the usage of screens in Brazil, where the climatic conditions demand natural ventilation for thermal comfort of users at the same time preventing insect entry.

6. Acknowledgements

This research was partially funded by CAPES, Fundação Meridional and DAAD. The authors also would like to acknowledge GIZ for the support, the companies Christophe Lenderoth GmbH and MGM for providing window samples to be tested in the wind-tunnel. Further, the authors would like to thank Felipe da Silva Duarte Lopes and Beatriz Arantes for their support with the setup of the experiments and Klaus Schweers for analyzing and calculating the air flow.

7. Referencias

- Allard, F.; Santamouris, M. (Eds.). (1998). Natural ventilation in buildings: a design handbook. London: James & James Ltd.
- ASHRAE. (2009). Handbook of fundamentals. American Society of Heating, Refrigerating and Air conditioning Engineers (ASHRAE).
- Awbi, H. B. (2003). Ventilation of Buildings. London: Taylor & Francis. <https://doi.org/10.4324/9780203476307>.
- Aynsley, R. (1999). Unresolved issues in natural ventilation for thermal comfort. In First International One day Forum on Natural and Hybrid Ventilation. Retrieved from <http://www.hybvent.civil.aau.dk/puplications/report/aynsley.pdf>
- Belleri, A.; Lollini, R.; Dutton, S. M. (2014). Natural ventilation design: An analysis of predicted and measured performance. Building and Environment, 81, 123–138. <https://doi.org/10.1016/j.buildenv.2014.06.009>.
- BSI. (2004). BS EN 13141-1: Ventilation for buildings - Performance testing of components/products for residential ventilation - Part 1: Externally and internally mounted air transfer devices. London: BSI.
- Chen, Q. (2009). Ventilation performance prediction for buildings: A method overview and recent applications. Building and Environment, 44(4), 848–858. <https://doi.org/10.1016/j.buildenv.2008.05.025>.
- Chiu, Y. H.; Etheridge, D. W. (2007). External flow effects on the discharge coefficients of two types of ventilation opening. Journal of Wind Engineering and Industrial Aerodynamics, 95(4), 225–252. <https://doi.org/10.1016/j.jweia.2006.06.013>
- Chu, C.; Lan, T.; Tasi, R.; Wu, T.; Yang, C. K. (2017). Wind-driven natural ventilation of greenhouses with vegetation. Biosystems Engineering, 164, 221–234. <https://doi.org/10.1016/j.biosystemseng.2017.10.008>.
- Chu, C. R.; Chiu, Y. H.; Chen, Y. J.; Wang, Y. W.; Chou, C. P. (2009). Turbulence effects on the discharge coefficient and mean flow rate of wind-driven cross-ventilation. Building and Environment, 44(10), 2064–2072. <https://doi.org/10.1016/j.buildenv.2009.02.012>.
- Cruz, H.; Viegas, J. C. (2016). On-site assessment of the discharge coefficient of open windows. Energy and Buildings, 126, 463–476. <https://doi.org/10.1016/j.enbuild.2016.05.051>
- Etheridge, D. (2012). Natural ventilation of buildings: theory, measurement and design. UK: John Wiley & Sons, Ltd.
- Etheridge, D. (2015). A perspective on fifty years of natural ventilation research. Building and Environment, 91, 51–60. <https://doi.org/10.1016/j.buildenv.2015.02.033>
- Etheridge, D. (2016). Design Procedures for Natural Ventilation. In Y. Tamura & R. Yoshie (Eds.), Advanced Environmental Wind Engineering (pp. 1-24). Beijing: Springer
- Flourentzou, F.; Van der Maas, J.; Roulet, C. A. (1998). Natural ventilation for passive cooling: measurement of discharge coefficients. Energy and Buildings, 27(3), 283–292. [https://doi.org/10.1016/S0378-7788\(97\)00043-1](https://doi.org/10.1016/S0378-7788(97)00043-1).
- Heiselberg, P.; Sandberg, M. (2006). Evaluation of Discharge Coefficients for Window Openings in Wind Driven Natural Ventilation. International Journal of Ventilation, Volume 5, (1), 43-52. <https://doi.org/10.1080/14733315.2006.11683723>.
- Heiselberg, P.; Svdt, K.; Nielsen, P. V. (2001). Characteristics of airflow from open windows. Building and Environment, 36, 859–869. [https://doi.org/10.1016/S0360-1323\(01\)00012-9](https://doi.org/10.1016/S0360-1323(01)00012-9).
- Hult, E. L.; Laccarino, G.; Fischer, M. (2012). Using Cfd Simulations To Improve Thermal modeling of window Discharge Coefficients. In Proceedings of SimBuild 2012 Fifth National Conference of IBPSA-USA, Madison, WI. (pp. 322–328).
- Idel'chik, I. E. (1966). Handbook of Hydraulic Resistance, Coefficients of Local Resistance and of Friction. Jerusalem: Monson.
- Iqbal, A.; Afshari, A.; Wigö, H.; Heiselberg, P. (2015). Discharge coefficient of centre-pivot roof windows. Building and Environment, 92, 635–643. <https://doi.org/10.1016/j.buildenv.2015.05.034>.
- Karava, P.; Stathopoulos, T.; Athienitis, A. K. (2004). Wind Driven Flow through Openings – A Review of Discharge Coefficients. International Journal of Ventilation, 3(3), 255–266. <https://doi.org/10.1080/14733315.2004.11683920>.
- Lamberti, G.; Gorié, C. (2018). Uncertainty quantification for modeling night-time ventilation in Stanford's Y2E2 building. Energy and Buildings, 168, 319–330. <https://doi.org/10.1016/j.enbuild.2018.03.022>.
- Linden, P.F. (1999). The fluid Mechanics. Annual. Review of Fluid Mechanics. V 31. Pp.201–38 <https://doi.org/10.0066-4189/99/0115-0201>.
- Ohba, M.; Kurabuchi, T.; Tomoyuki, E.; Akamine, Y.; Kamata, M.; Kurahashi, A. (2004). Local Dynamic Similarity Model of Cross-Ventilation Part 2 - Application of Local Dynamic Similarity Model. International Journal of Ventilation, 2 (4), 383–394. <https://doi.org/10.1080/14733315.2004.11683680>.
- Scarpa, M.; Mazzali, U.; Peron, F. (2014). Modeling the energy performance of living walls: Validation against field measurements in temperate climate. Energy and Buildings, 79, 155–163. <https://doi.org/10.1016/j.enbuild.2014.04.014>.
- Shirzadi, M.; Mirzaei, P. A.; Naghashzadegan, M. (2018). Development of an adaptive discharge coefficient to improve the accuracy of cross-ventilation air flow calculation in building energy simulation tools. Building and Environment, 127 (July 2017), 277–290. <https://doi.org/10.1016/j.buildenv.2017.10.019>.
- Tamura, Y.; Yoshie, R. (Eds.). (2016). Advanced Environmental Wind Engineering. Beijing: Springer.
- Wang, J.; Wang, S.; Zhang, T.; Battaglia, F. (2017). Assessment of single-sided natural ventilation driven by buoyancy forces through variable window configurations. Energy & Buildings, 139, 762–779. <https://doi.org/10.1016/j.enbuild.2017.01.070>.
- Yi, Q.; Li, H.; Wang, X.; Zong, C. (2019). Numerical investigation on the effects of building configuration on discharge coefficient for a cross-ventilated dairy building model. Biosystems Engineering, 182, 107–122. <https://doi.org/10.1016/j.biosystemseng.2019.04.003>.
- Yi, Q.; Wang, X.; Zhang, G.; Li, H.; Janke, D.; Amon, T. (2019). Assessing effects of wind speed and wind direction on discharge coefficient of sidewall opening in a dairy building model – A numerical study. Computers and Electronics in Agriculture, 162 (April), 235–245. <https://doi.org/10.1016/j.compag.2019.04.016>.
- Yi, Q.; Zhang, G.; König, M.; Janke, D.; Hempel, S.; Amon, T. (2018). Investigation of discharge coefficient for wind-driven naturally ventilated dairy barns. Energy & Buildings, 165, 132–140. <https://doi.org/10.1016/j.enbuild.2018.01.038>.

