

Performance of simple concrete pipes produced with the incorporation of rubber tires

Comportamiento de tubos circulares de hormigón simple producidos con adición de caucho de neumáticos

J. Akasaki *, C. Fioriti ¹*, R. Queiroz *, A. Fugii *, J. Pinheiro *

* Universidade Estadual Paulista, UNESP. BRAZIL

Fecha de Recepción: 14/07/2015

Fecha de Aceptación: 23/02/2016

PAG 27-36

Abstract

In this work we have studied the performance of simple concrete pipes produced with the incorporation of rubber tires with contents of 10, 15 and 20 kg/m³ of concrete. The experimental program included diametral compression strength and water absorption tests. Twelve pipes were tested and divided into four sets of three pipes of nominal diameter (ND) of 600 mm and length of 1500 mm. Each series consisted of three pipes stub and bag (SB), one control (without rubber tires), and three sets incorporating rubber pipes on the trace (TB1, TB2 and TB3). All test results showed diametral compressive strength values higher than that specified the NBR 8890 standard, with respect to simple concrete pipes PS2 class: type SB with ND 600 mm, which is 36 kN/m. In the water absorption test all pipes had absorption values less than the maximum established in the NBR 8890 standard, which is 8%. It can be concluded from the results and specific conditions of the tests conducted, that the tire rubber has the potential to be incorporated into the manufacture of simple concrete pipes. However, it is stated that it is necessary to increase the knowledge about the behavior of concretes incorporating rubber tire.

Keywords: Simple concrete pipes, rubber tires, diametral compression, water absorption

Resumen

En este trabajo se estudiaron tubos de hormigón simple elaborados con la adición de caucho de neumáticos en proporciones de 10, 15 y 20 kg/m³ de hormigón. El programa experimental incluye la realización de ensayos de resistencia a la compresión diametral y absorción de agua. Se evaluaron doce tubos, con un diámetro nominal (DN) de 600 mm y longitud de 1500 mm, separados en cuatro series de tres tubos cada una. Cada serie estaba formada por tres tubos tipo punta y bolsa (PB): una serie de control (sin caucho de neumáticos) y tres series con incorporación de tres diferentes concentraciones de caucho en la mezcla para los tubos (TB1, TB2 e TB3). Todos los resultados de los ensayos de resistencia a la compresión diametral presentaron valores superiores a los especificados en la norma NBR 8890 para los tubos de hormigón simple clase PS2: tipo PB con DN de 600 mm, cuyo valor es de 36 kN/m. En los ensayos de absorción de agua, todos los tubos presentaron valores de absorción inferiores al máximo establecido en la norma NBR 8890, cuyo valor es de 8%. Se puede concluir, que el caucho de neumático tiene potencial para ser incorporado en la fabricación de tubos de hormigón simple. No obstante, es imperativo ampliar el conocimiento sobre el comportamiento del hormigón preparado con caucho de neumáticos.

Palabras clave: Tubos de hormigón simple, caucho de neumáticos, compresión diametral, absorción de agua

1. Introduction

There are many interesting and curious reports about the use of pipes designed to direct the flow of water and sewage since ancient times to the present day. In those days, the precepts of hygiene were closely related to religion. Most buildings were more intended to the display of their creators than to improving the quality of life of the population served by the system.

During the Roman Empire, plain concrete pipes, able to withstand external loads, could already be found. In Paris, in the nineteenth century, there were large sewers systems which were coated by stones adhered with cement mortar (ACPA, 1993). In the last 25 years of the nineteenth century, several concrete pipes were installed in the United States. The technique used is little known, but it was probably by trial and error (ACPA, 1980).

According to that reported elsewhere (ACPA, 1980), the development of the buried pipes theory began in 1897 when F. A. Barbour performed six tests on entrenched pipes of 914.4 mm diameters and grounded height of 1000 mm to 2500 mm. In these tests, Barbour used a hydraulic platform to apply the forces on the buried pipes.

Currently, throughout the world the main construction alternative for drainage urban sewage and storm water galleries refers to circular concrete pipes, which may be of the stub and bag (SB), type or male and female type. In Brazil, the circular pipes with SB geometry are the most widely used.

The use of circular plain concrete pipes and circular reinforced concrete pipes has increased due to their durability and good mechanical strength, and also because it is an available product that meets the market demands.

As the pipes are manufactured by factories close to the regions where they will be used, they also help promote local development by generating jobs and tax revenue. Over the years, the structural design of circular concrete pipes has grown, mainly because of the experimental investigations about pipe and soil interaction.

¹ Corresponding Author:

Faculdade de Ciências e Tecnologia, Departamento de Planejamento, Urbanismo e Ambiente, Universidade Estadual Paulista – UNESP. Brazil
E-mail: fioriti@fct.unesp.br



Parallel to the development and increased use of concrete pipes, due to a number of reasons, it is well known that the use of construction waste has become increasingly important. It is also known that the number of vehicles in circulation increases every year, which among other things, causes the generation of by-products from vehicles, for instance, waste from the mechanical tire retreading process. Retreading mainly regards making use of the sturdy structure of the worn tire, provided it is in good conditions, and incorporating to it a new rubber base (tread), in order to make a rebuild tire.

According to estimates, 70% of freight and passenger vehicles in Brazil use tires made with this technique, thus making our country second place in the world ranking. The tire basically retains the same behavioral characteristics of the original tire, at much lower costs. In terms of the new tire it represents about 75% in savings, both at raw material and energy levels. Retreading increases tire life by 40% and saves 80% of energy and raw material for the production of new tires (CEMPRE, 2013).

On the other hand, tire retreading is a source that greatly contributes to buildup of rubber residues obtained during this process, and these residues are in the form of fibers and rubber powder. The visual impact caused by retreading residue is negative, and open-area residue tires deposits offer suitable conditions for the development of various types of vectors, in addition to the risks of fire.

On the other hand, results show that the production of concrete with rubber tires implies a significant decrease in the apparent mass density in the fresh state and in the hardened state, the compressive strength and the flexural tensile strength (RAGHVAN et al., 1998; DHIR et al., 2003).

However, there is a decrease in the modulus of elasticity but a better performance in hard body impact resistance. Thus, this behavior (enhanced ductility) is a feature that improves the durability of the material – while

water absorption does not appear to be significantly affected (FIORITI et al., 2010; JOHN, 2000).

The aim of this work was to investigate the performance of plain concrete rainwater drainage pipes produced by incorporating different tire rubber contents (10, 15 and 20 kg/m³ of concrete), using diametral compression strength and water absorption tests of the pipes produced in the present work.

2. Materials and methods

2.1 Cement

The cement used was HES-CPV (high early strength Portland cement) in accordance with the requirements of NBR 5733 (ABNT, 1991), a widely used type of cement in the production of precast concrete elements.

2.2 Aggregates

Natural sand and crushed stone (from basalt) were used and its characterization are based on following tests: NBRNM 248 (ABNT, 2003) particle size; NBRNM 30 (ABNT, 2001) water absorption and NBRNM 53 (ABNT, 2003); absolute mass density NBRNM 52 (ABNT, 2009) and NBRNM 53 (ABNT, 2003); NBRNM 45 (ABNT, 2006) apparent mass density; NBRNM 49 (ABNT, 2001) organic material and NBRNM 46 (ABNT, 2003) powdery materials. Table 1 shows the characterization.

2.3 Tire rubber

The rubber used was obtained through the off-road tire retreading mechanical process. These residues have a very diverse dimensions (Figure 1), and their size separation at the processing site is an impossible practice. Thus, it was decided to perform the selection by a laboratory screening process.

Table 1. Characterization of the aggregates

| | Maximum diameter (mm) | Fine modulus | Absorption (%) | Pulverulent material | Organic material | Specific mass | |
|---------------|-----------------------|--------------|----------------|----------------------|------------------|-------------------------------|-------------------------------|
| | | | | | | Apparent (g/cm ³) | Absolute (g/cm ³) |
| Sand | 4.75 | 2.36 | 0.28 | 0.44 | + clear | 1.554 | 4.75 |
| Crushed stone | 19.00 | 6.59 | 2.08 | 0.88 | – | 1.593 | 19.00 |



Figure 1. Tire retreading residues in the natural state

ENGLISH VERSION.....

During the processing of the scrap tire rubber sample, the steel and nylon or any other impurities that could significantly affect the concrete performance were discarded. The fraction used was all the material passing through the sieve (2.38 mm mesh size), which on average represented 80% of the total volume of the material. This process resulted in a more uniform material fraction, predominantly a maximum waste size of 8 mm. Thus, 20% of the remaining material was composed of large pieces of the tire band tread, which were excluded from this study. The rubber was characterized through the following tests: NBRNM 248 (ABNT, 2003) particle size; NBRNM 52 (2009) specific mass density and apparent mass density NBRNM 45 (2006).

same that is practiced by the factory, therefore, the composition chosen is the same one used by this company in the manufacture and marketing of the pipes they produce. This option was chosen, based on the fact that the casting equipment influences the quality characteristics of the pipes and according to information from the factory, the composition used had been developed with specific purposes for the equipment and materials they used. Moreover, the lack of pipe production equipment in the laboratories used in this study was also a factor that enabled the agreement with the pipes company that allowed using its facilities, material and equipment for this work. Table 3 shows the concrete compositions for making the pipes for both the control one and the rubber modified ones.

2.4 Concrete traces of pipes

It was decided that the control trace would be the

Table 2. Characterization of rubber tires

| | Maximum diameter (mm) | Fine modulus | Absorption (%) | Pulverulent material | Organic material | Specific mass | |
|--------|-----------------------|--------------|----------------|----------------------|------------------|-------------------------------|-------------------------------|
| | | | | | | Apparent (g/cm ³) | Absolute (g/cm ³) |
| Rubber | 4.75 | 3.81 | - | - | - | 0.348 | 1.090 |

Table 3. Concrete traces used in the manufacture of pipes

| | Cement (kg) | Sand (kg) | Crushed stone (kg) | Water (kg) | Water/cement relation | Rubber (kg) | Rubber content (kg/m ³) |
|---------|-------------|-----------|--------------------|------------|-----------------------|-------------|-------------------------------------|
| Control | 40.00 | 80.00 | 100.00 | 16.00 | 0.40 | - | - |
| TB1 | 40.00 | 80.00 | 100.00 | 16.00 | 0.40 | 1.40 | 10 |
| TB2 | 40.00 | 80.00 | 100.00 | 16.00 | 0.40 | 2.00 | 15 |
| TB3 | 40.00 | 80.00 | 100.00 | 16.00 | 0.40 | 2.70 | 20 |

The manufacturing of the pipes was performed in a concrete vibrating drum (Figure 2) as it is indicated for compact industrial production

The curing of the pipes was performed at ambient conditions for 7 days, keeping a constant humidity of the pipes stock through water spraying.



Figure 2. Densification of concrete by the vibration production system



ENGLISH VERSION.....

2.5 Dimensions of the concrete pipes

The plain concrete pipes, PS2 class, type PB: NBR 8890 (ABNT, 2007), to be used as rain water drainage pipes,

were manufactured according to the dimensions of Table 4 and details given in Figures 3 and 4.

Table 4. Dimensions of plain concrete pipes in mm

| Nominal (ND) | Weight (kg by linear meter) | Internal diameter (ID) | Total length (L) | Thickness (E) | External diameter (DE) |
|--------------|-----------------------------|------------------------|------------------|---------------|------------------------|
| 600 | 310 | 600 | 1500 | 60 | 880 |

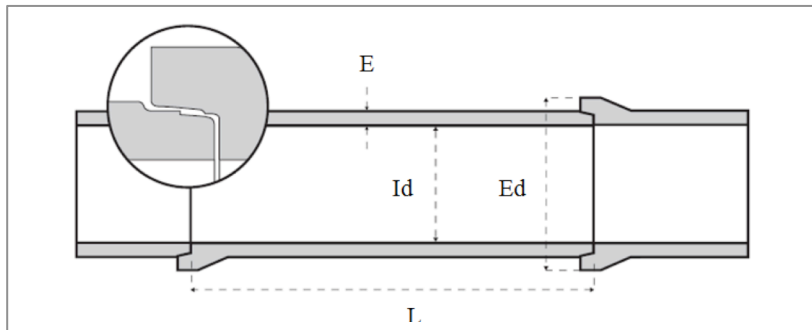

Figure 3. Illustration of plain concrete pipe (type SB) according to NBR 8890 (ABNT, 2007)



Figure 4. Plain concrete pipes with rubber tires

2.6 Diametral compression strength

The structural design of concrete pipes is related to the determination of the loads acting on the buried pipe, and these may be permanent (the action of landfills or slopes) or mobile (the action of vehicles). Thus, the diametral compression strength test for the concrete pipes was made following the NBR 8890 (ABNT, 2007).

For the plain concrete pipe tests, only the failure load is determined. The test procedure begins with the measuring of the effective length (L) of the pipe along three generatrices, out of phase with each other by an angle of 120 degrees, and the value of the useful length equal to the average of the three measurements. The pipe is placed on the flat and horizontal supports, parallel and symmetrical to its axis; these supports consist of straight wood laths in equal or longer lengths than the pipe; a straight wood beam of greater than or equal to the length of the pipe is placed along the generatrix of the pipe. To avoid the concentration of efforts on possible surface irregularities of the pipe, a strip of rubber about 5 mm thick, or a layer of sand can be intercalated between the pipe and each bar. The set should be arranged so that the load application point coincides with half the effective length value

of the pipe, in order to ensure uniform load distribution along its length. The load should be applied with a constant rate of no less than 5 kN/min and no more than 35 kN/min per meter of pipe, until the occurrence of failure. Figure 5 shows the test setup for a pipe with SB-type encasement ends.

The monitoring of the applied load was performed by a data acquisition system connected to a microcomputer through DasyLab software. The equipment was connected to a load cell with 50 tons of maximum capacity, coupled between the piston of the hydraulic jack and the distribution beam of the applied load, as shown in Figure 6. For the test, a rod was used to allow the accommodation of deformations, taking into account that the pipe does not have perfectly cylindrical dimensions. It is noted that for SB-type pipes the loading is not applied in the pocket region, as in Figure 6, however, the pocket region is also affected by the loading effect, hence advisable dividing the force by the effective length of the pipe, in this case 1500 mm.

Three plain concrete pipes were molded by trace, for each age, with failure at 28 days of age, taking as ultimate strength their arithmetic mean.

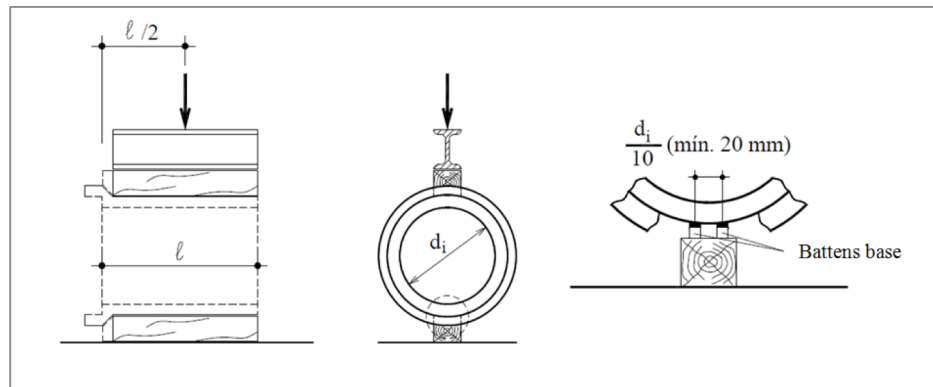

Figure 5. Test scheme for diametral compression strength pipe with SB-type encasement ends, according to NBR 8890 (ABNT, 2007)

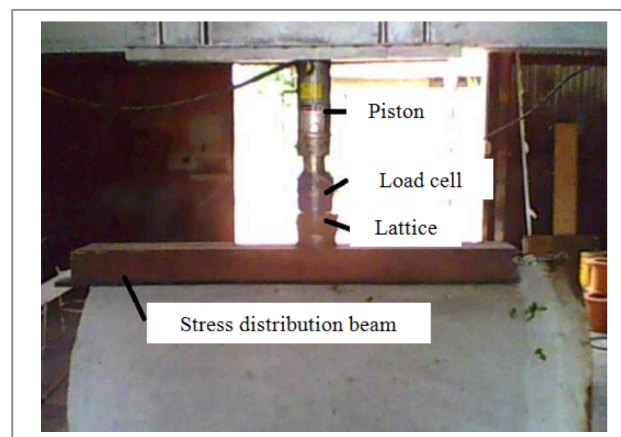

Figure 6. Load application system used in the test of pipes

2.7 Water absorption

The water absorption rate in plain concrete pipes was carried out according to NBR 8890 (ABNT, 2007). The maximum water absorption relative to its dry mass is limited to 6% for sewage and 8% for rain water. Thus, from the pipes subjected to diametrical compression test, at 28 days of age, two non-deformable test specimens per pipe are extracted, resulting in a surface area ranging from 100 cm² to 150 cm², with no visible cracks.

The specimens should be oven dried with temperature kept at the range of (105 ± 5)°C, for a minimum of 8 hours, until in two consecutive weightings, with no less than two hours interval, they evidence mass loss variation of less than 0.1% of its original mass. Once dry the specimens are placed in appropriate containers, immersed in potable boiling water (100°C) and kept in boiling water for 5 hours. Next, the specimens are left to cool in the water in their containers until they reach room temperature; then the samples should be dried with a towel, damp cloth or absorbent paper, and weighed. The water absorption is given by Equation (1):

$$A = \frac{M_1 - M_0}{M_0} * 100 \quad (1)$$

where: A = water absorption (%); M₀ = dry specimen mass (g); M₁ = specimen mass after the saturated test (g).

3. Results and discussion

3.1 Diametrical compression strength

Figure 7 shows the results of the diametrical compression tests, where the control pipe (with no tire rubber) showed the highest value. Theoretically, the higher

the incorporation content of tire rubber to the concrete, the lower its resistance; however, this behavior was not observed for the TB2 pipe, which had the highest value among the pipes with rubber. The difference between the TB1 pipe and TB2 pipe was of 1.70%; and between the TB2 pipe and TB3 pipe it was of 4.62%. It was thus noted that up to 15 kg/m³ of rubber concentration incorporated into the concrete of the pipes, the decrease of the diametrical compression strength value is not as intense and after that concentration the diametral compression strength decreases considerably (48.20 kN/m). Still, all pipes used in the tests exceeded the diametrical compression value imposed by the NBR 8890 (2007) for plain concrete pipes (PS2) type SB with ND of 600 mm, which is 36 kN/m.

Taking into consideration the results found in references (SIDDIQUE and NAIK, 2004; SUKONTASUKKUL and CHAIKAE, 2006; FIORITI et al., 2010), which used rubber tires contents ranging from 3% to 15% in their compositions, found that the concrete with this waste range tends to lose compressive strength and has lower traction than when percentages above 15% are used.

Figures 8, 9 and 10 show the load time behaviors for the concrete pipes with tire rubber waste during the diametrical compression tests. After reaching CMID, determined by NBR 8890 (ABNT, 2007), the pipe must support this load for one minute; and then the load must be increased until the pipe reaches failure. If the rubber had a fiber behavior, which it did not happen in this case, the load should be removed and then reapplied until reaching the damage free minimum load value; This load must be supported for one minute, then the load should be increased until it reached the value corresponding to 5% more of the damage free minimum load value.

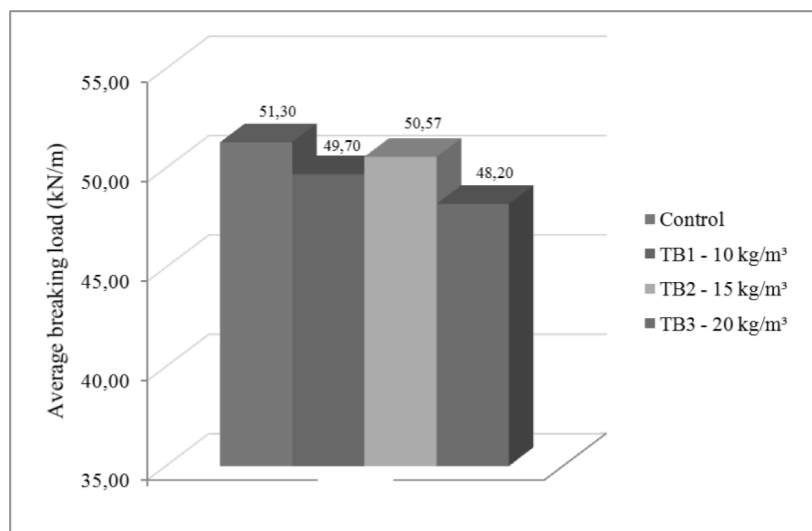

Figure 7. Results of diametrical compression tests

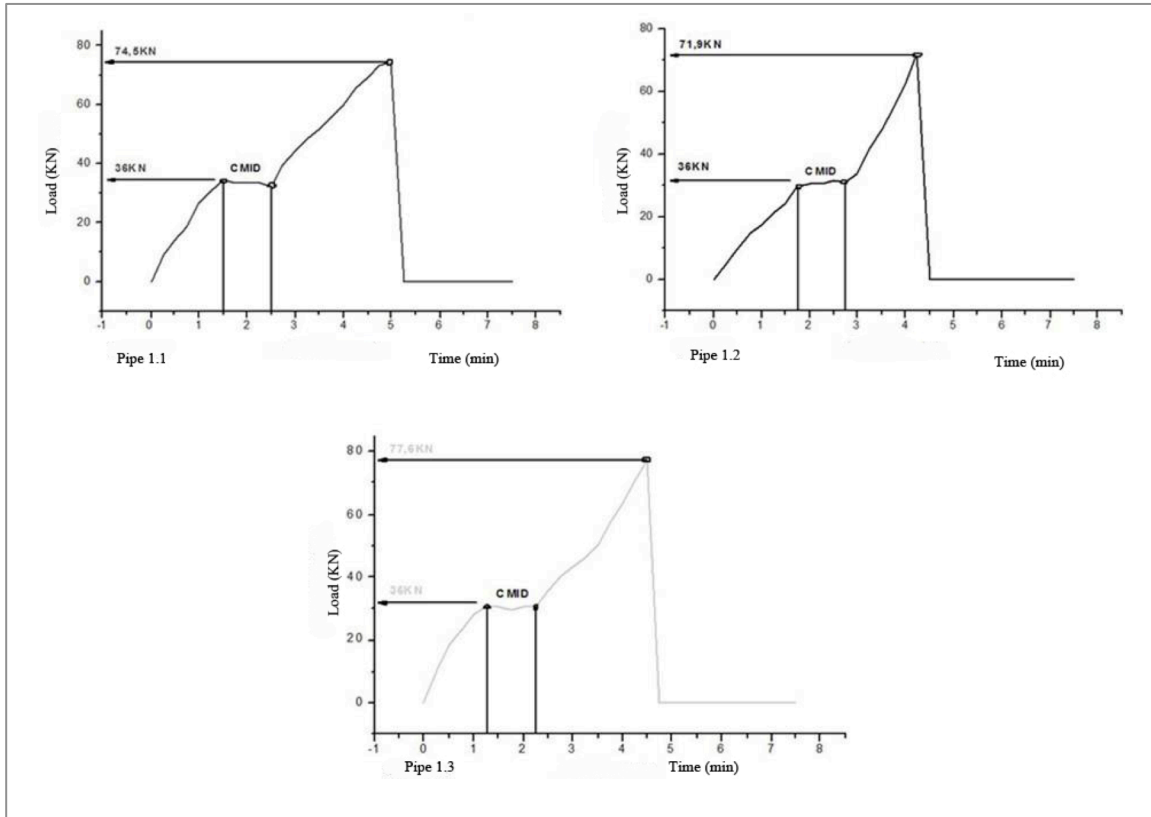

Figure 8. Charts of load versus time for TB1 pipes – 10 kg/m³

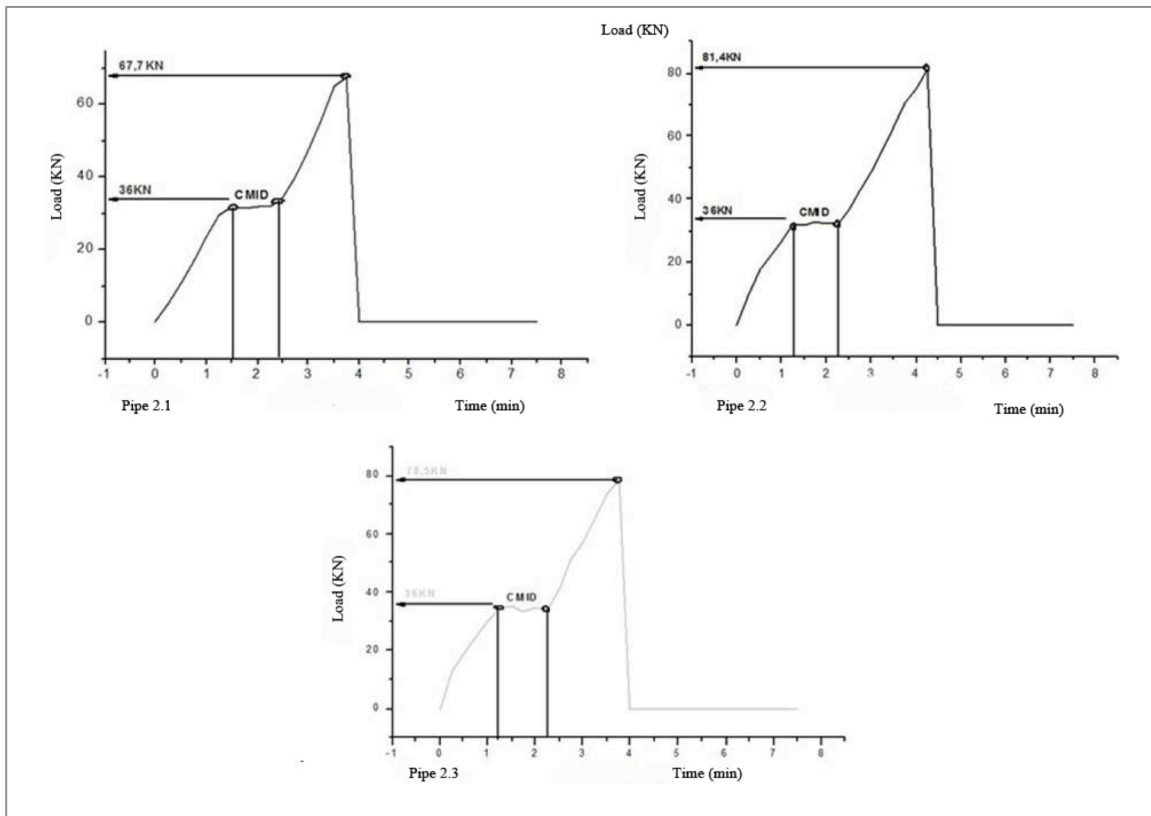

Figure 9. Charts of load versus time for TB2 pipes – 15 kg/m³

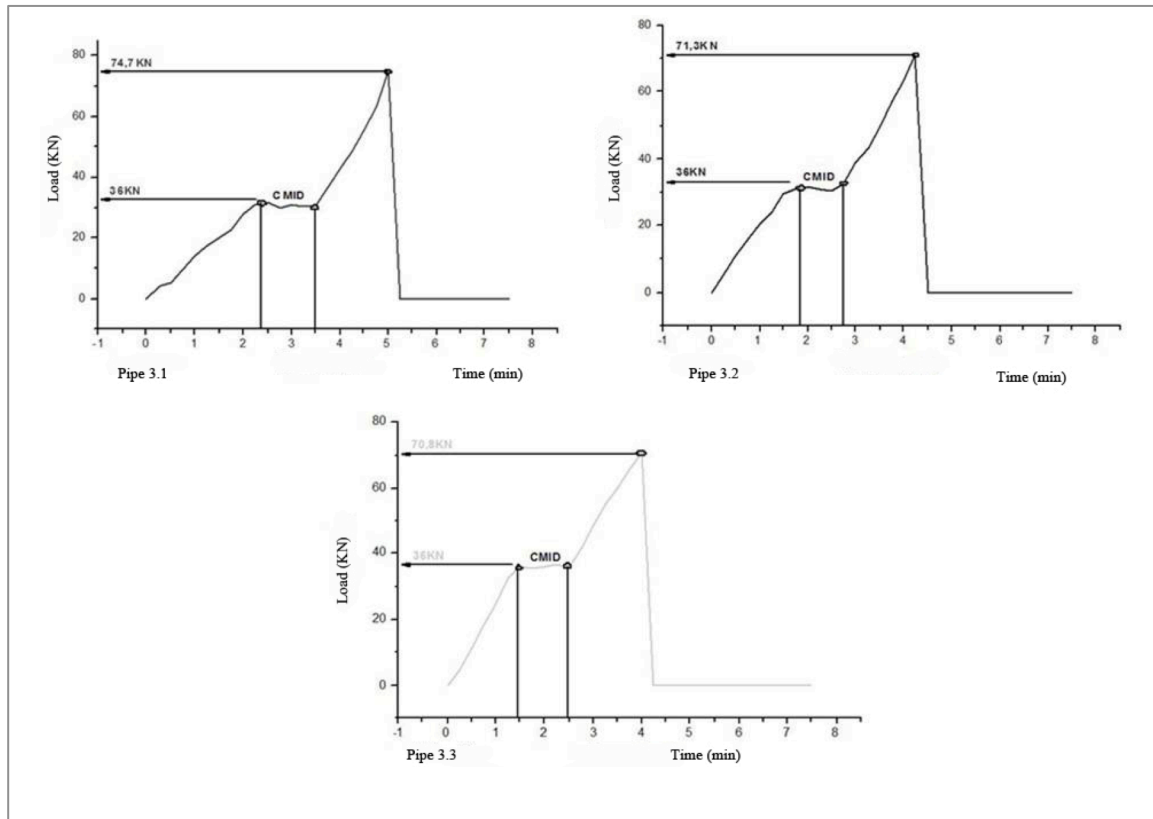

Figure 10. Graphs of load versus time for TB3 pipes – 20 kg/m³

The amount of recycled tire rubber used in each concrete trace was determined based on other work (FUGIL, 2008), which used a corresponding amount of steel fibers. This procedure was performed in order to verify if the rubber would exhibit the behavior of fibers, which did not occur.

Thus, in the diametral compression strength tests shown in Figures 8, 9 and 10, it was observed that they were

not fully completed as determined by NBR 8890 (ABNT, 2007), which is shown in Figure 11, because there was a sudden failure of all pipes manufactured with tire rubber. Therefore, the second step of the test, which was reloading, could not be executed. The sharp failure form (Figure 12) indicated that the rubber did not act like fiber.

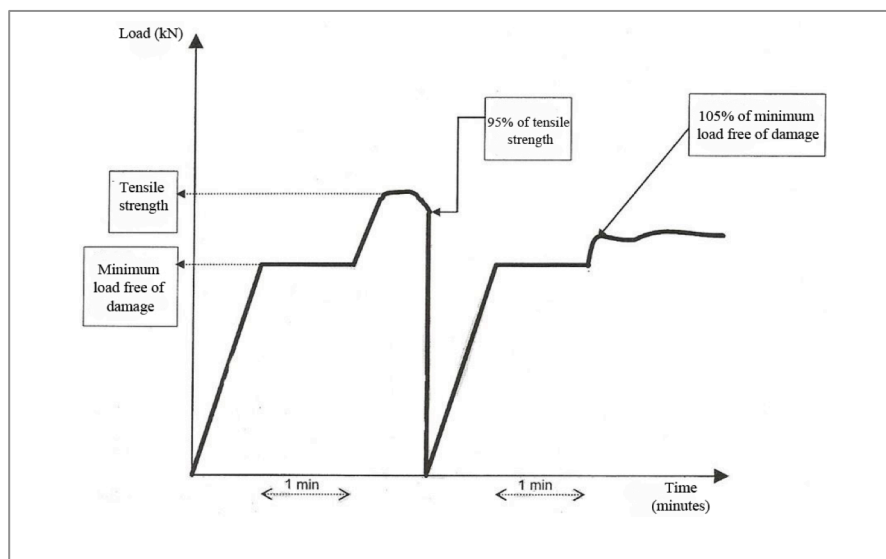

Figure 11. Schematic of load plan of the diametral compression test for pipes reinforced with steel fibers, NBR 8890 (ABNT, 2007)



Figure 12. Concrete pipe produced with rubber after the sudden failure

One of the difficulties encountered during this test was the fact that the machine applies the load for performing the test manually, which greatly depends on the operator's sensitivity. It is observed in the time load graphs (Figures 8, 9 and 10) for example, that at the CMID level there were small oscillations, but nothing that could compromise the final test result.

3.2 Water absorption

Figure 13 shows the results of water absorption capacity for all the pipes produced.

Through Figure 13, it was found that the average absorption for all concrete pipes are in the range from 3.7% to 4.10%, below the value given NBR 8890 (ABNT, 2007), which sets a maximum absorption for a rainwater drainage pipe at 8%. Therefore, the incorporation of tire rubber into the concrete, within the range studied, fulfill the standard.

It was noted that the TB1 and TB2 pipes showed the lowest water absorption averages (3.70%). Given the results of the pipes with rubber tires, as well as the diametral compression results, the incorporation of rubber to the limit of

15 kg/m³ showed the best results. Moreover, all pipes with the incorporation of tire rubber showed lower water absorption values than the control pipe, indicating that an improvement of that property cannot be asserted, but can confirm controversies in the literature, where some researchers claim that this property is not influenced, and others argue that greater absorption occurs due to the tire rubber particle size used.

According to (RAGHVAN et al., 1998; DHIR et al., 2003), which analyzed different particle sizes of tire rubber in concrete, concluded that water absorption capacity underwent interference with the dimensions of the rubber particles, since for the finer particle size the water absorption was lower.

It was then found that the use of tire rubber in the manufacture of plain concrete pipes does not alter the water absorption property, based on the fact that all concrete pipes with the incorporation of tire rubber obtained water absorption averages slightly lower than the water absorption average of the control pipe.

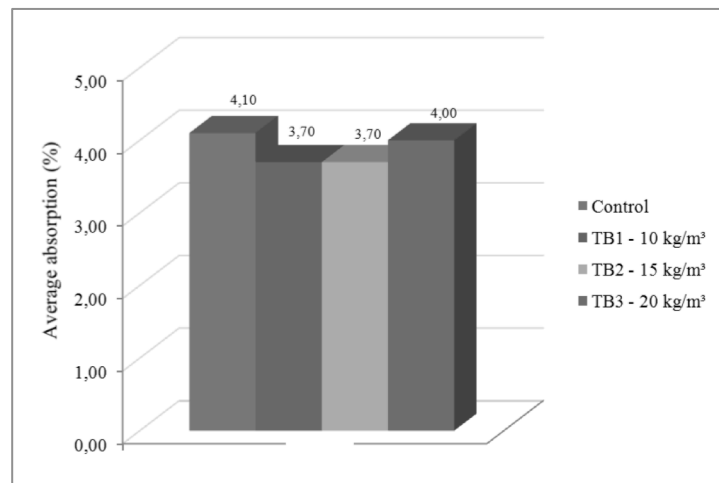

Figure 13. Results of the water absorption tests

4. Conclusions

A drier concrete consistency is used in the production of concrete pipes, since the pipes need to be deformed within a few minutes to continue the production of the others. The use of this type of concrete implies a greater workability problem of the material. However, as the tire rubber was added during the preparation of the concrete, there was no increased difficulty to produce them, in other words, a new production stage was not created since the rubber homogenized in the mix. However reinforced concrete pipes require the preparation of steel reinforcement, adding a new stage in its production.

Regarding the diametrical compression strength tests, given the observed behavior, it can be seen that the tire rubbers did not behave as a type of fiber, given the sudden failure observed in the respective tests. Nevertheless, all pipes showed higher resistance to that specified by NBR 8890 (ABNT, 2007), with respect to the PS2 simple concrete pipes: type SB with ND of 600 mm, which is of 36 kN/m.

The pipe with rubber that achieved the highest diametrical compression strength and hence the lowest water absorption capacity was TB2 (15 kg/m³ content), thus higher and lower, respectively, than the control concrete pipe.

It should be noted that none of the pipes with tire rubber were able to fully complete the diametrical compression strength test required by the standard, in other words, the rubber did not behave as if it was fiber, therefore, the pipes could be considered as if they were made of plain concrete (PS2).

In the water absorption tests all the pipes had absorbance values less than the maximum determined by NBR 8890 (ABNT, 2007) which is of 8%.

It can then be concluded, based on the results obtained and for the specific conditions of the tests conducted, that the tire rubber has the potential to be incorporated in to the manufacturing of plain concrete pipes.

However, it should be stated that it is necessary to expand the knowledge about the behavior of concrete produced with the incorporation of tire rubber

5. References

- Associação Brasileira de Normas Técnicas – ABNT. (2001)**, NBRNM 30: Agregado miúdo – determinação da absorção de água. Rio de Janeiro, Brasil.
- Associação Brasileira de Normas Técnicas – ABNT. (2006)**, NBRNM 45: Agregados – determinação da massa unitária e do volume de vazios. Rio de Janeiro, Brasil.
- Associação Brasileira de Normas Técnicas – ABNT. (2003)**, NBRNM 46: Agregados – determinação do material fino que passa através da peneira 75 µm, por lavagem. Rio de Janeiro, Brasil.
- Associação Brasileira de Normas Técnicas – ABNT. (2001)**, NBRNM 49: Agregado miúdo – determinação de impurezas orgânicas. Rio de Janeiro, Brasil.
- Associação Brasileira de Normas Técnicas – ABNT. (2009)**, NBRNM 52: Agregado miúdo – determinação de massa específica e massa específica aparente. Rio de Janeiro, Brasil.
- Associação Brasileira de Normas Técnicas – ABNT. (2003)**, NBRNM 53: Agregado graúdo – determinação da massa específica, massa específica aparente e absorção de água. Rio de Janeiro, Brasil.
- Associação Brasileira de Normas Técnicas – ABNT. (2003)**, NBRNM 248: Agregados – determinação da composição granulométrica. Rio de Janeiro, Brasil.
- Associação Brasileira de Normas Técnicas – ABNT. (1991)**, NBR 5733: Cimento Portland de alta resistência inicial. Rio de Janeiro, Brasil.
- Associação Brasileira de Normas Técnicas – ABNT. (2007)**, NBR 8890: Tubo de concreto de seção circular para águas pluviais e esgotos sanitários – requisitos e métodos de ensaio. Rio de Janeiro, Brasil.
- American Concrete Pipe Association – ACPA. (1980)**, Concrete pipe handbook. Vienna, Virginia: ACPA.
- American Concrete Pipe Association – ACPA. (1993)**, Concrete pipe technology handbook: a presentation of historical and current state-of-the-art design and installation methodology. Tex, Irving: ACPA.
- Compromisso Empresarial para Reciclagem – CEMPRE. (2013)**, Ficha técnica. In: PNEUS. Available in: <<http://www.cempre.org.br>>. September 22, 2013.
- Raghvan, D., Huynh, H., Ferraris, C. F. (1998)**, Workability, mechanical properties, and chemical stability of a recycled tyre rubber-fillet cementations composite. *Journal of Materials Science*, v.33. 1745-1752.
- Dhir R., Paine K. E. y Moroney R. (2003)**, Recycling of used tyres in concrete. *Concrete*, v. 37(9), 47-48.
- Fioriti C. F., Ino A. y Akasaki J. L. (2010)**, Análise experimental de blocos intertravados de concreto com adição de resíduos do processo de recauchutagem de pneus. *Acta Scientiarum. Technology (Impresso)*, v.32, 237-244.
- John V. M. (2000)**, Construção e desenvolvimento sustentável. *Qualidade*, 23, ano III, 34-44.
- Siddique R., Naik T. R. (2004)**, Properties of concrete containing scrap-tire rubber – an overview. *Waste Management*, 24, 1-7.
- Sukontasukkul P., Chaikaew C. (2006)**, Properties of concrete pedestrian block mixed with crumb rubber. *Construction and Building Materials*, 20, 450-457.
- Fugii A. P. (2008)**, Avaliação de tubos de concreto reforçados com fibras de aço segundo a NBR 8890 (Dissertação de Mestrado em Engenharia Civil). Ilha Solteira, Brasil: Universidade Estadual Paulista.

